

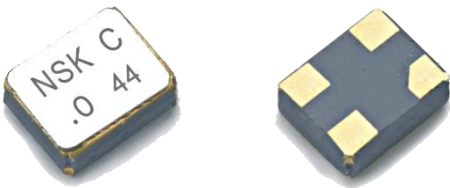









NAOL Series 2.5 x 2.0

	Application : <ul style="list-style-type: none">  Portable PC / Digital camera  Wireless Lan / DOA Terminal  Portable multimedia player  PCMCIA card / SD card  CCD / HDD
	Features : <ul style="list-style-type: none">  Low power consumption  RoHS compliant / Pb free  Excellent solderability  Seam welding  Tri-State



Electrical Specification :

Model		NAOL-22		
1. Frequency				
Frequency Range	MHz	4.0 ~ 125.0		
Frequency Stability	PPM	A: ±100 B: ±50 C: ±30 D: ±25		
Operating Temp Range	°C	0 ~ +70, -40 ~ +85 or specify		
Storage Temp Range	°C	-55 ~ +125		
Output Level		CMOS		
Output Symmetry	%	40% ~ 60% (at 50%VDC)		
Power Supply Voltage	VDC	3.3V±10%	2.5V±5%	1.8V±5%
2. Current Consumption				
4.00 MHz ~ 9.99 MHz	mA Max.	7	6	6
10.00 MHz ~ 19.99 MHz		7	8	8
20.00 MHz ~ 31.99 MHz		12	8	8
32.00 MHz ~ 50.00 MHz		20	20	20
50.01 MHz ~ 125.0 MHz		30	30	30
3. Rise and Fall Time				

* Above specification subject to change without prior notice, please consult our sales representative for more information*

TAIWAN — JENJAAN QUARTEK CORPORATION

Address : 3F-5, No 504 Yun Shan Road, Chung Ho City, Taipei, Taiwan
 Tel : +886-2-8221-4498 Fax : +886-2-8221-4499
 E-mail : jjenjaan@jenjaan.com.tw Web : http://www.nsk.com.tw

FACTORY - DONG GUAN ALLIED PROJECT LIMITED

Address : No. 703, Fu Min Zhong Road, Yang Yong Village, Dalang
 Town, Dong Guan, Guang Dong, China Tel : +86-769-8311-9395
 Fax : +86-769-8313-0880 E-mail : alliedj@pub.dgnet.gd.cn

SMD TYPE CERAMIC OSCILLATORS



1.00 MHz ~ 9.99 MHz	ns Max.	6	7	7
10.00 MHz ~ 19.99 MHz		6	7	7
20.00 MHz ~ 31.99 MHz		5	6	6
32.00 MHz ~ 50.00 MHz		5	9	9
50.01 MHz ~ 125.0 MHz		5	9	9
4. Output Load	pF	15		
5. Aging	PPM/Year	±3		

Dimensions (mm) :

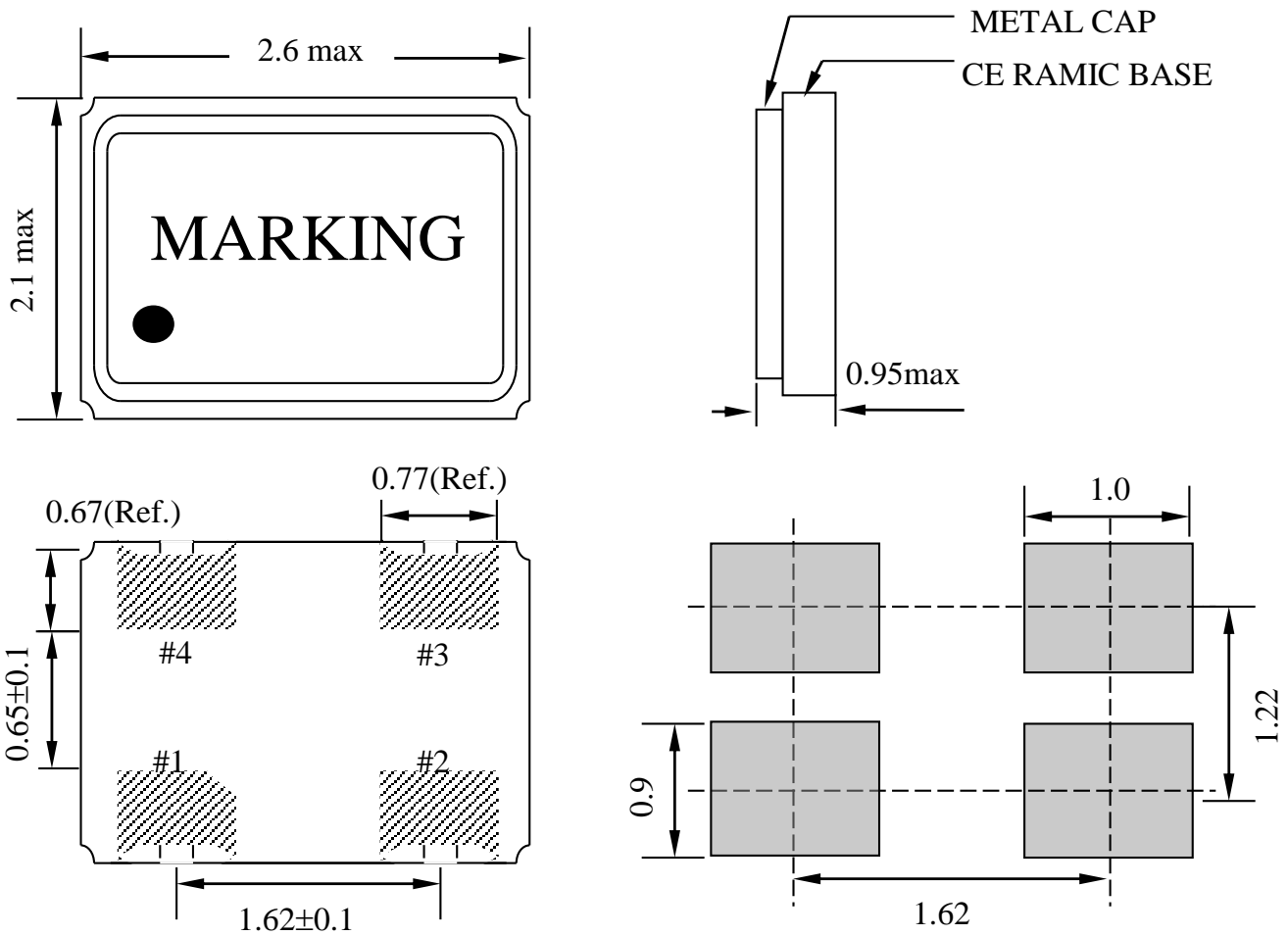

#1: ENABLE / DISABLE FUNTION

INH (PIN 1)	→	OUTPUT (PIN 3)	# NO.: define	
High (OPEN)	→	Operating	#4: VDD	#3: OUTPUT
LOW	→	High impedance	#1: E/D	#2: GND

* Above specification subject to change without prior notice, please consult our sales representative for more information*

TAIWAN — JENJAAN QUARTEK CORPORATION

Address : 3F-5, No 504 Yun Shan Road, Chung Ho City, Taipei, Taiwan
 Tel : +886-2-8221-4498 Fax : +886-2-8221-4499
 E-mail : jenjaan@jenjaan.com.tw Web : http://www.nsk.com.tw

FACTORY - DONG GUAN ALLIED PROJECT LIMITED

Address : No. 703, Fu Min Zhong Road, Yang Yong Village, Dalang
 Town, Dong Guan, Guang Dong, China Tel : +86-769-8311-9395
 Fax : +86-769-8313-0880 E-mail : alliedj@pub.dgnet.gd.cn

Tape Specification(mm) :

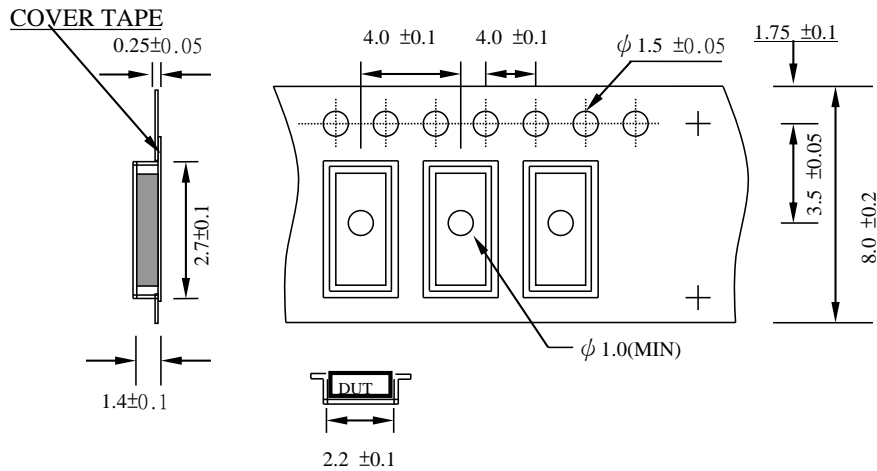

Reel Packing(mm) :

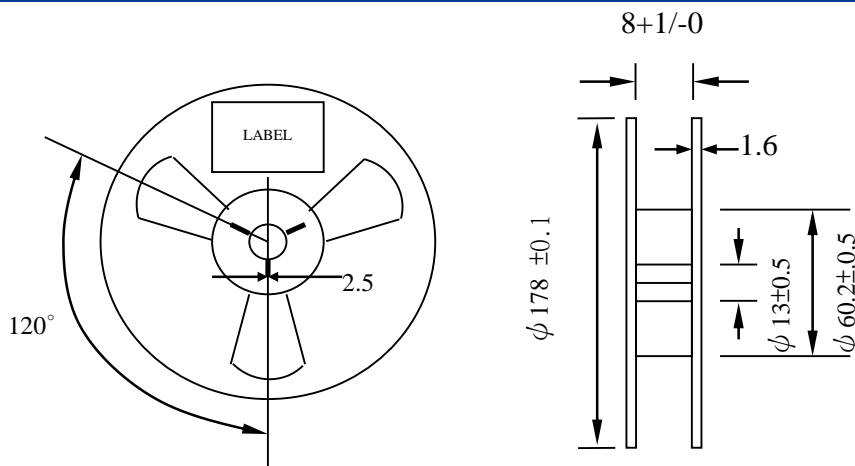

Reflow Temperature Profile :

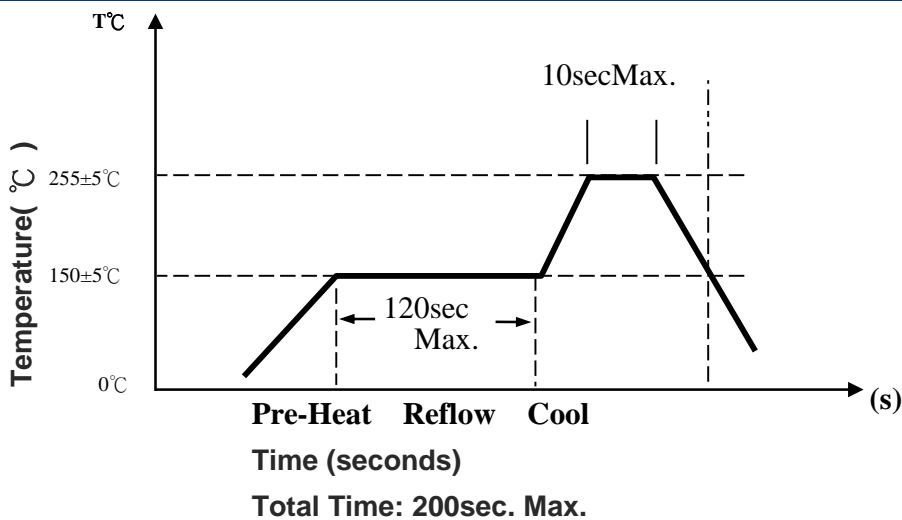

* Above specification subject to change without prior notice, please consult our sales representative for more information*

TAIWAN — JENJAAN QUARTEK CORPORATION

Address : 3F-5, No 504 Yun Shan Road, Chung Ho City, Taipei, Taiwan

Tel : +886-2-8221-4498

E-mail : jenjaan@jenjaan.com.tw

Fax : +886-2-8221-4499

Web : <http://www.nsk.com.tw>

FACTORY - DONG GUAN ALLIED PROJECT LIMITED

Address : No. 703, Fu Min Zhong Road, Yang Yong Village, Dalang

Town, Dong Guan, Guang Dong, China Tel : +86-769-8311-9395

Fax : +86-769-8313-0880

E-mail : alliedj@pub.dgnet.gd.cn