

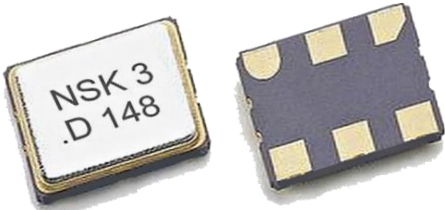











## NADK Series 3.2 x 2.5

  	<b>Application :</b> <ul style="list-style-type: none"> <li> XDSL / VoIP, Cable modem</li> <li> Jitter Attenuator, ADC</li> <li> Set-top Box, HDTV</li> <li> WiMAX / WLAN</li> </ul>
	<b>Features :</b> <ul style="list-style-type: none"> <li> Low phase jitter (12KHz to 20MHz) under 1 ps (RMS)</li> <li> Tri-state function available</li> <li> RoHS compliant / Pb free</li> <li> Differential output</li> </ul>



## Electrical Specification :

Model		NADK-32
<b>1. Frequency</b>		
Frequency Range	MHz	25.0 ~ 200.0
Frequency Stability	PPM	A: ±100 B: ±50 C: ±30 D: ±25
<b>2. Temperature Range</b>		
Operating Temp Range	°C	-10 ~ +70, -40 ~ +85 or specify
Storage Temp Range	°C	-55 ~ +125
Output Voltage High (V <sub>OH</sub> )	V (Min.)	0.9
Output Voltage Low (V <sub>OL</sub> )	V (Max.)	1.6
Output Load	Ω	100
Output Symmetry	%	45% ~ 55%
<b>3. Input Voltage</b>		
Enable High Input Voltage	V (Min.)	0.7 VDD
Enable Low Input Voltage	V (Max.)	0.3 VDD
Current	mA (Max.)	80
Rise / Fall Time (20% / 80%)	nS (Max.)	1.0
Aging	Ppm / Year	±3
Start Up Time	mS (Max.)	10

\* Above specification subject to change without prior notice, please consult our sales representative for more information\*

### TAIWAN — JENJAAN QUARTEK CORPORATION

Address : 3F-5, No 504 Yun Shan Road, Chung Ho City, Taipei, Taiwan  
 Tel : +886-2-8221-4498 Fax : +886-2-8221-4499  
 E-mail : jenjaan@jenjaan.com.tw Web : http://www.nsk.com.tw

### FACTORY - DONG GUAN ALLIED PROJECT LIMITED

Address : No. 703, Fu Min Zhong Road, Yang Yong Village, Dalang  
 Town, Dong Guan, Guang Dong, China Tel : +86-769-8311-9395  
 Fax : +86-769-8313-0880 E-mail : alliedj@pub.dgnet.gd.cn

## Dimensions (mm) :

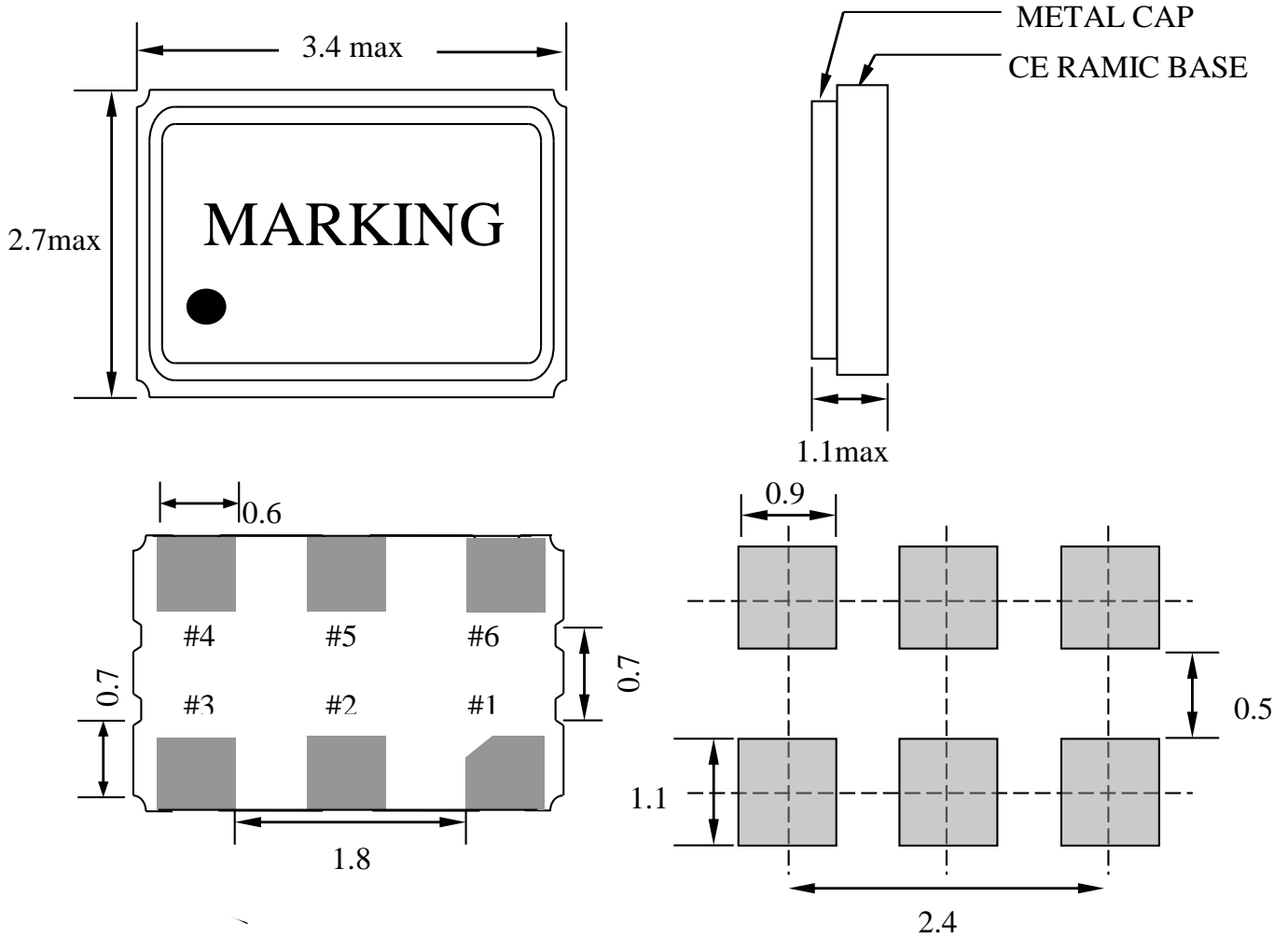

# NO.: Pin define		
#6: VDD	#5: Comp Output	#4: Output
#1: Vcon	#2: Tri-State	#3: GND

\* Above specification subject to change without prior notice, please consult our sales representative for more information\*

### TAIWAN — JENJAAN QUARTEK CORPORATION

Address : 3F-5, No 504 Yun Shan Road, Chung Ho City, Taipei, Taiwan  
 Tel : +886-2-8221-4498 Fax : +886-2-8221-4499  
 E-mail : jenjaan@jenjaan.com.tw Web : http://www.nsk.com.tw

### FACTORY - DONG GUAN ALLIED PROJECT LIMITED

Address : No. 703, Fu Min Zhong Road, Yang Yong Village, Dalang  
 Town, Dong Guan, Guang Dong, China Tel : +86-769-8311-9395  
 Fax : +86-769-8313-0880 E-mail : alliedj@pub.dgnet.gd.cn

## Tape Specification(mm) :

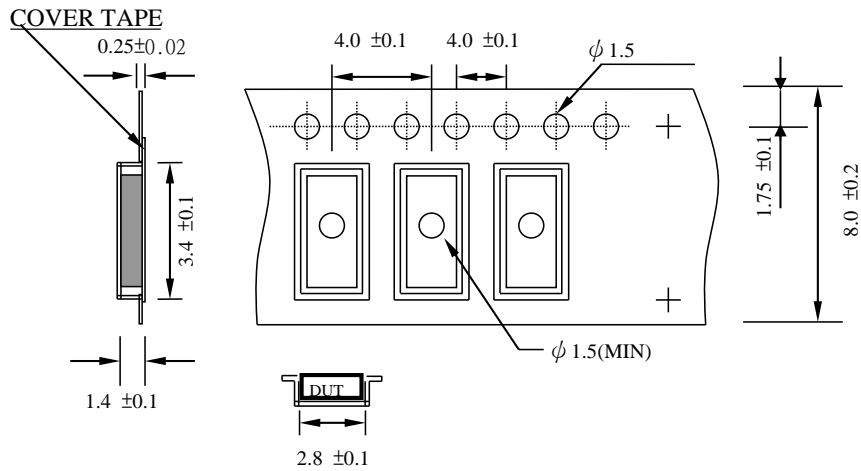

## Reel Packing(mm) :

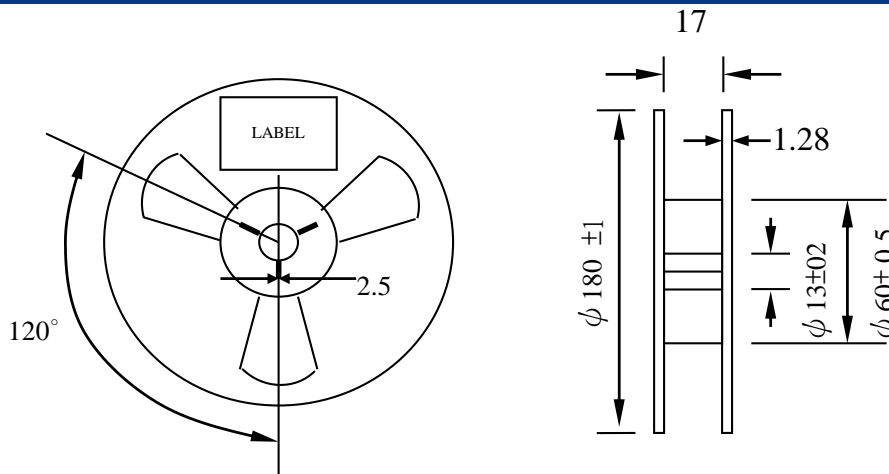

## Reflow Temperature Profile :

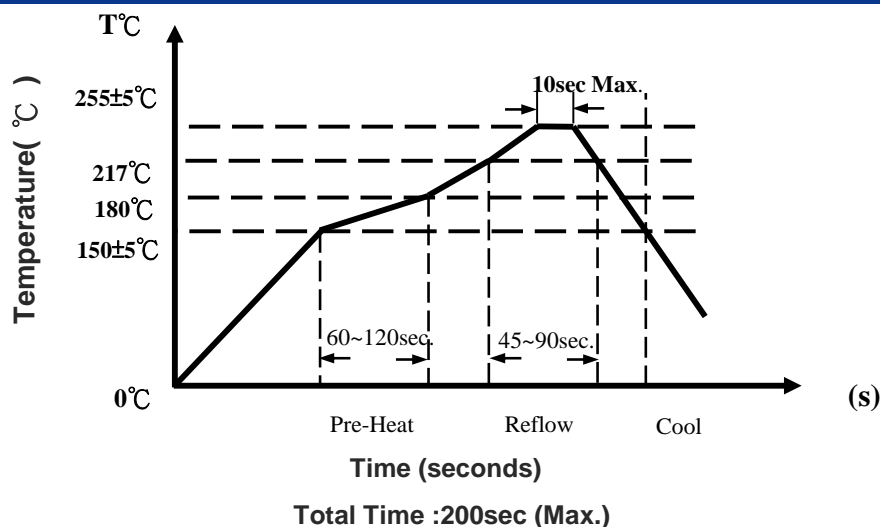

\* Above specification subject to change without prior notice, please consult our sales representative for more information\*

TAIWAN — JENJAAN QUARTEK CORPORATION

Address : 3F-5, No 504 Yun Shan Road, Chung Ho City, Taipei, Taiwan  
 Tel : +886-2-8221-4498 Fax : +886-2-8221-4499  
 E-mail : jenjaan@jenjaan.com.tw Web : http://www.nsk.com.tw

FACTORY - DONG GUAN ALLIED PROJECT LIMITED

Address : No. 703, Fu Min Zhong Road, Yang Yong Village, Dalang  
 Town, Dong Guan, Guang Dong, China Tel : +86-769-8311-9395  
 Fax : +86-769-8313-0880 E-mail : alliedj@pub.dgnet.gd.cn